



INSTALLATION GUIDE

BBT042/ BBC042/ BBCD042

NISSAN NAVARA D40 V6 2010+ STX
& PATHFINDER R51 2010+
2WD & 4WD Models



- Ironman 4x4 BBT/ BBC/ BBCD042 Bull Bars fit to a Nissan Navara D40 STX & Pathfinder R51.
Does not fit pre-2010.
- It will take about 4 hours to install.

NOTE: This product has been tested for air bag compatibility and therefore the mounting system MUST NOT be modified

IMPORTANT: Bull Bar installations should only be done by a qualified person and it is the responsibility of this person to ensure correct fitment.

1. Before installation check bull bar application is compatible with your vehicle.

2. Remove all mounting hardware holding lower section of front bumper bar to vehicle.

3. Mask cut line across bumper bar as shown.

NOTE: If your bumper bar has a recessed line across the front, the bull bar will NOT fit your vehicle.



4. Cut along line and remove lower section of bumper.



5. Trim plastic bumper bar reinforcement level with bumper cut.

6. Place cutting template onto end of bumper as shown and mark cut line.

NOTE: The cutting template is located on the last two pages of this installation guide.



7. Cut along line marked and repeat on other side of vehicle.



8. Install pinch weld to cuts on ends of bumper bar.



9. Trim guard liners along line as shown and remove square section adjacent to edge of bumper as shown.



10. Remove steel bumper bar reinforcement.



11. Install chassis bracket as shown.

NOTE: Before tightening bolt **A**, check for clearance with radiator. If required use extra washers supplied under head of bolt to provide clearance.

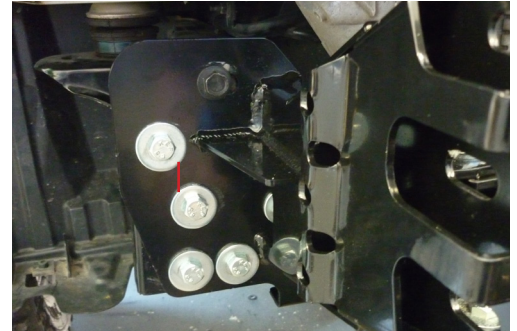
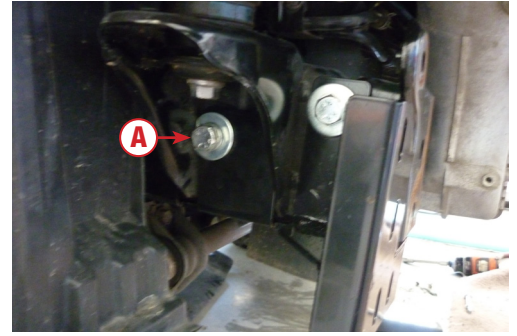

NOTE: Before tightening, adjust bull bar mounts so that the mounting faces for the bar are 815mm apart and centralised to vehicle.

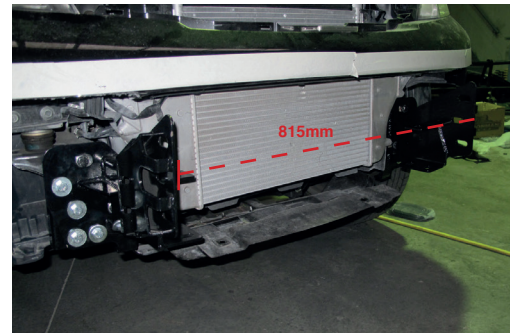

12. Install winch cradle as shown.



13. If winch is being installed, refer to winch installation instructions, Pages 6 - 7.

14. Unwrap bull bar. Check over riders and light assemblies are tight in bull bar before installation.

15. Fit bull bar to chassis brackets using M12 bolts, flat washers, spring washers and nuts provided.

16. Align bull bar with vehicle and tighten all bolts.

17. Once bar is aligned with vehicle and tightened drill through pinning holes between bull bar and chassis bracket and secure with bolts, washers and nuts provided.

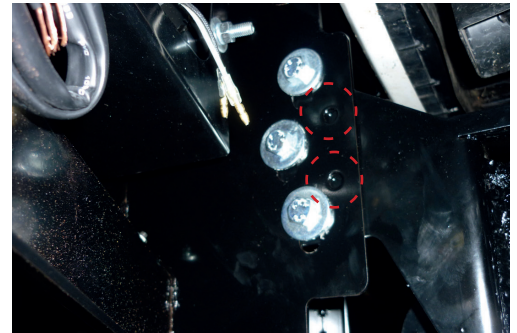

18. Connect park lights, indicators and fog lights as per wiring diagrams at the back of fitting instruction manual.

19. Fit protection plates to underneath of bull bar using M8 bolts, spring washers and flat washers provided.



Winch Installation

1. Bolt winch to cradle with gearbox to the left hand side of vehicle and cable spooling from bottom of the cable drum using bolts and washers provided.

NOTE: Center section of bumper bar will need to be cut away to allow clearance for the winch.



2. Bolt fairlead to recess in front of bull bar using bolts, washers and nuts provided.



3. Fit bull bar to vehicle referring to steps 15 - 17 of bull bar fitting instructions.

4. Mount control box in desired location.

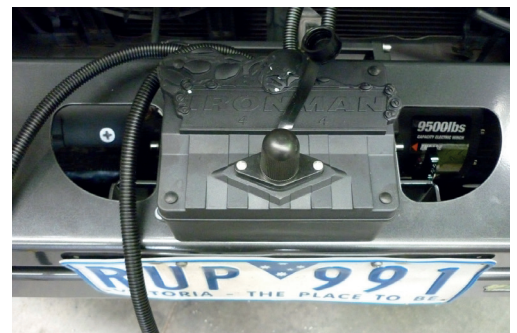

5. Connect three colour coded cables to the corresponding poles on winch motor.



12. Connect the thin black earth wire and negative battery cable to the earth connection on the opposite side of winch motor.



13. Run the positive and negative battery cables into the engine bay taking care to secure cables away from any sharp or moving objects.

14. Connect positive and negative battery cables main battery of vehicle (Not Auxilliary Battery).

15. Attach breather hose to barb fitting on winch motor. Run hose to the highest available point in engine bay and cable tie in position. Cable tie hose away from any sharp, hot or moving objects.



Wiring Diagrams

PARK LIGHT & INDICATOR

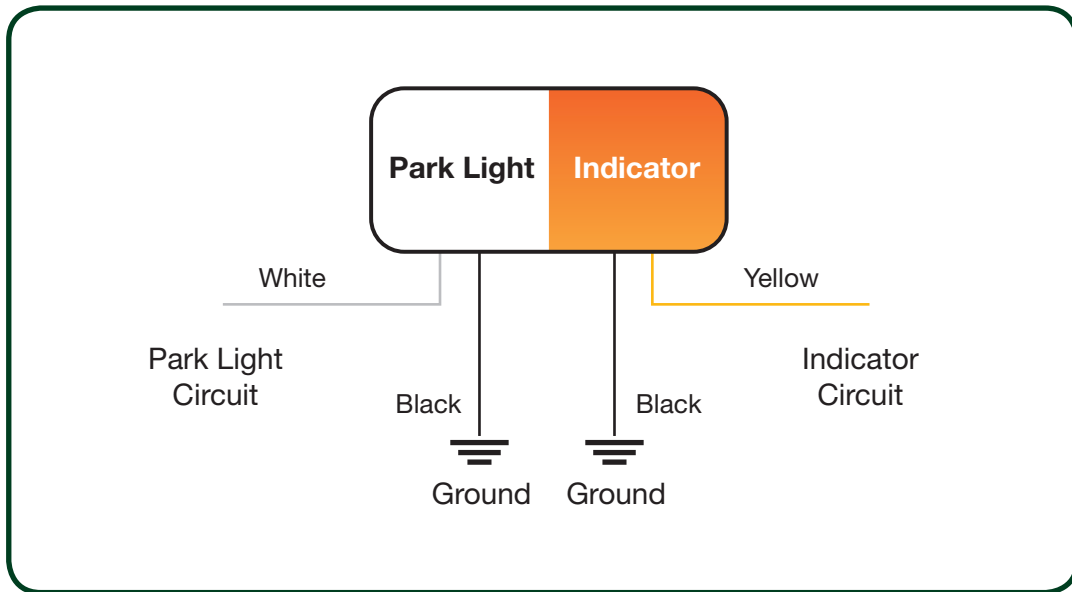

FOG LIGHTS

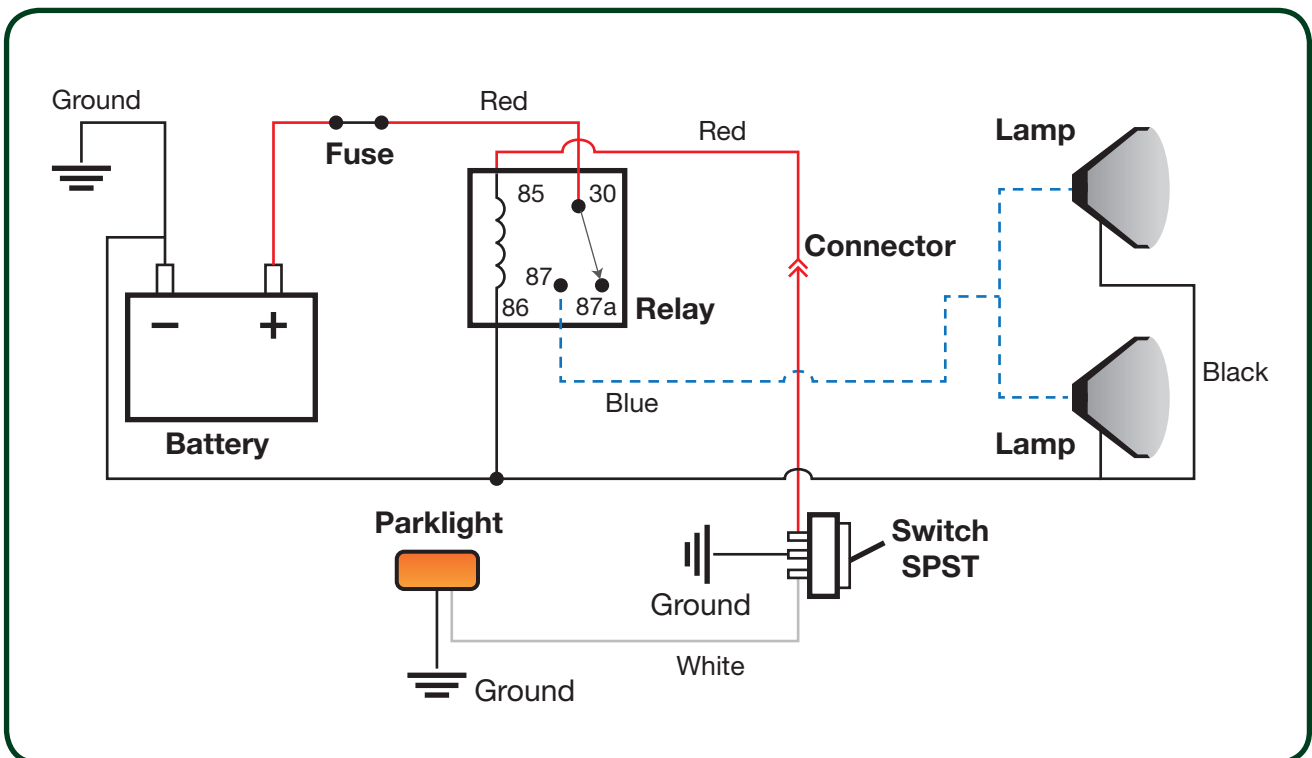

BUMPER LINE



**NISSAN NAVARA D40 STX V6
IRONMAN 4X4 BULLBAR
BUMPER CUTTING TEMPLATE**

Suit Part Number: BB_042

**+61 3 9532 1111
1300 731 137**

www.ironman4x4.com

WHEEL ARCH

LEFT SIDE OF PAGE
CUT OUT TEMPLATE

CUT

A3

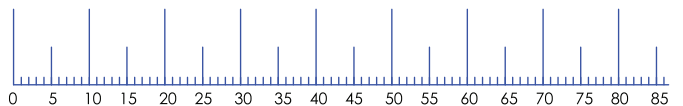

HEADLIGHT

To Front



RIGHT SIDE OF PAGE
CUT OUT TEMPLATE

CUT

