

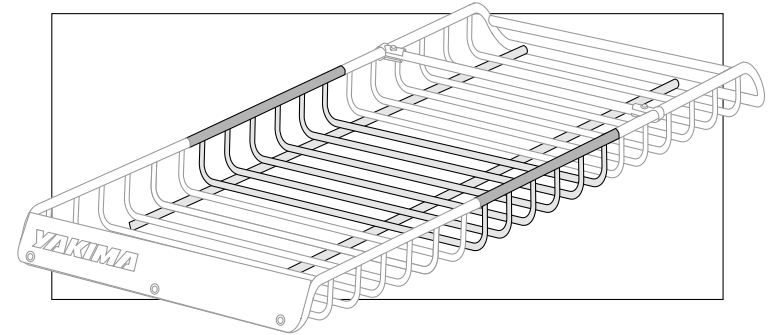

# YAKIMA MEGAWARRIOR EXTENSION

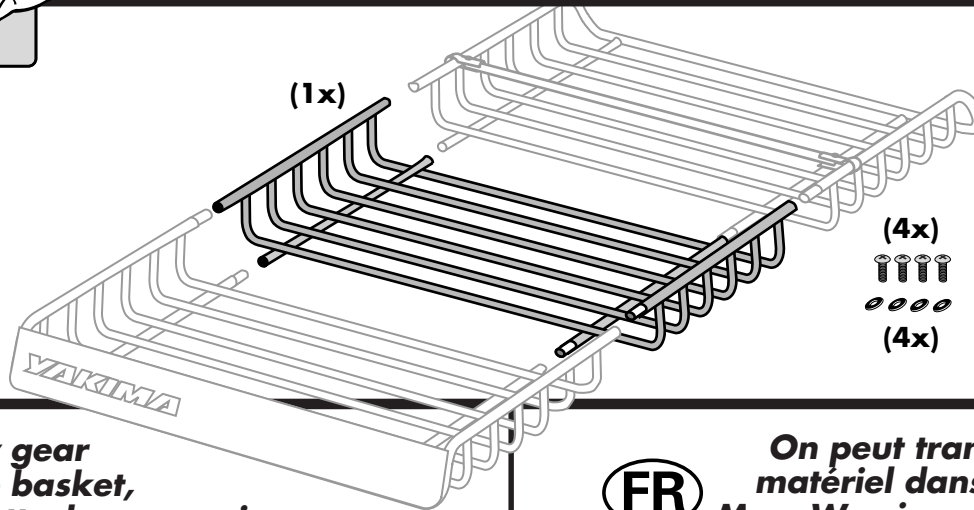

Carry gear in the basket, and attach accessories directly to the **MegaWarrior** (using accessory instructions).



**FR** On peut transporter le matériel dans le panier **MegaWarrior** et y monter directement des accessoires (en suivant les instructions qui les accompagnent).

**ES** Transporte el equipo en la cesta y fije los accesorios directamente al **MegaWarrior** (siga las instrucciones para accesorios).

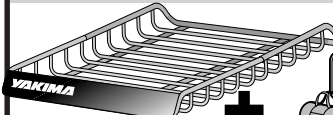
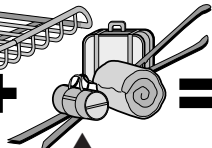

## **LOAD LIMITS:**

## **LIMITES DE CHARGE:**

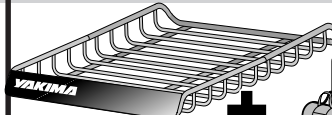
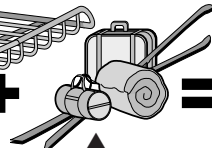

## **LIMITES DE CARGA:**

 +  =  **DO NOT EXCEED YOUR RACK'S weight limit!**

**45 lbs. (21 kg)** basket contents

 +  =  **NE PAS DÉPASSER LA LIMITE DE CHARGE du porte-bagages!**

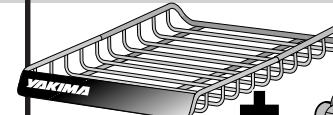
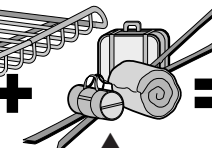
**45 lbs. (21 kg)** contenu de panier

 +  =  **NO SUPERE el límite de peso DE LA PARRILLA.**

**45 lbs. (21 kg)** contenido de la cesta



**DISTRIBUTE YOUR LOAD EVENLY INSIDE THE BASKET.**



**RÉPARTIR LA CHARGE ÉGALEMENT DANS LE PANIER.**



**DISTRIBUYA LA CARGA PAREJA DENTRO DE LA CESTA.**



**DO NOT EXCEED BASKET CONTENT WEIGHT LIMIT: 115 LBS. (52 KG)**

**Always tie down long loads at front and rear.**



**NE PAS DÉPASSER LA LIMITE DE CHARGE DANS LE PANIER: 52 kg (115 lb)**

**Toujours attacher les charges longues à l'avant et à l'arrière.**



**NO SUPERE EL LÍMITE DE PESO DEL CONTENIDO DE LA CESTA: 115 lbs (52 kg)**

**Siempre ate las cargas largas al frente y atrás del vehículo.**

US

# 1 IF YOU ALREADY HAVE A MEGAWARRIOR INSTALLED:

- Remove it from your car.
- Disassemble the brackets and set them aside.
- Separate the two basket halves by removing the screws at the joints.

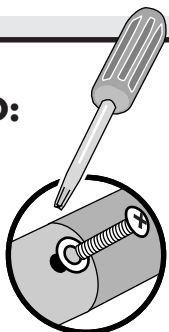

# 2 INSERT THE EXTENSION.

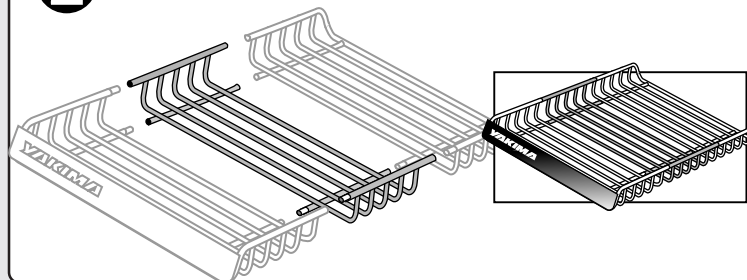

# 3

Insert screws and washers into each of the 8 joints and tighten.

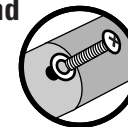

# 4 • IF YOU HAVE FIXED BARS:

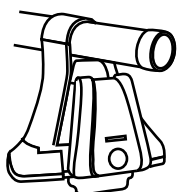

IF YOU HAVE "Q TOWERS" OR BARS THAT CANNOT MOVE...

Continue to STEP 5.



**Q TOWER OWNERS: NEVER REPOSITION THE Q TOWERS!**

# • IF YOUR BARS MOVE:

IF YOU HAVE BARS THAT CAN BE MOVED...  
Move the bars apart to a minimum of 36".

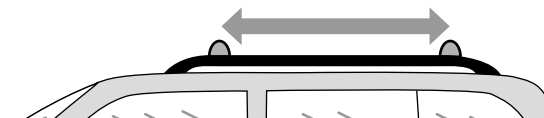

**TIGHTEN YOUR CROSSBARS IF YOU LOOSENED THEM.**

# 5 ATTACH FAIRING.

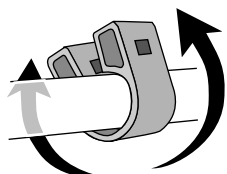

Pry open the SnapArounds, attach them to the LOWER FRONT BAR.

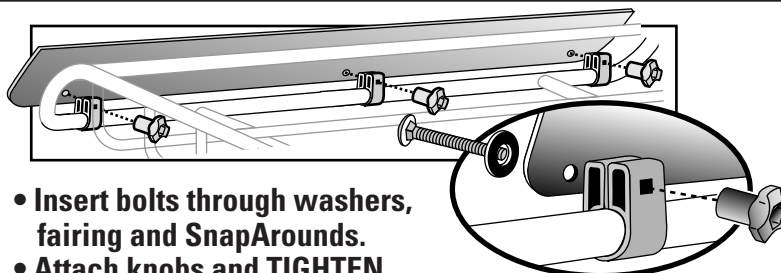

- Insert bolts through washers, fairing and SnapArounds.
- Attach knobs and TIGHTEN.

NOTE: The fairing can fold down when carrying long slender loads.

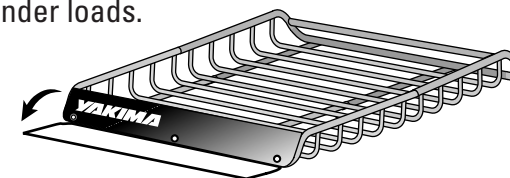

# 6 LOAD BASKET ONTO RACKS. Center basket over your rack's crossbars.

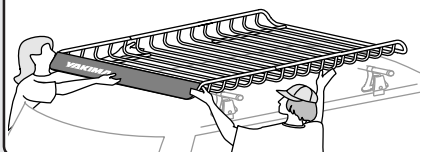

*A friend would make this easier.*



**DO NOT ATTACH BRACKETS TO UNSTABLE POINTS.**



Do not attach brackets at these locations.

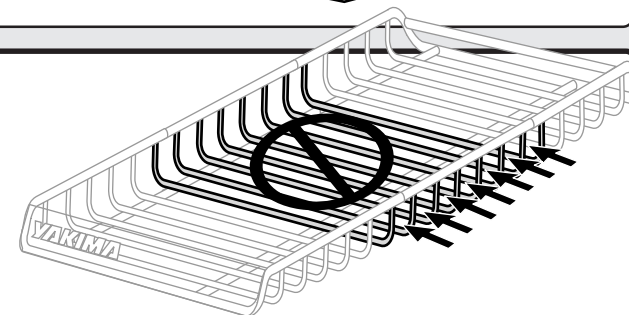

**Reassemble attachment hardware and secure the Extended MegaWarrior — OR — continue with step 5 of the MegaWarrior instructions.**

FR

**1**

**SI UN PANIER MEGAWARRIOR EST DÉJÀ INSTALLÉ:**

- L'enlever du véhicule.
- Démontez les étriers et les mettre de côté.
- Séparer les deux moitiés du panier en enlevant les vis des joints.



**2**

**INSÉRER L'ALLONGE MEGAWARRIOR.**

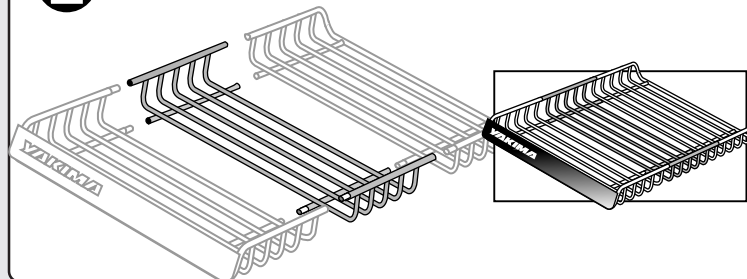

**3**

Poser les vis dans les huit joints et les serrer.

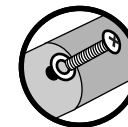

**4**

**• SI LES BARRES SONT FIXES:**

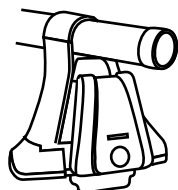

ISI L'ON A DES "PIEDS Q" OU DES BARRES QUI NE BOUGENT PAS...

passer à l'opération **5**.

**• SI LES BARRES SONT MOBILES:**

S'IL EST POSSIBLE DE DÉPLACER LES BARRES... placer les barres à au moins 91 cm (36 po) l'une de l'autre.

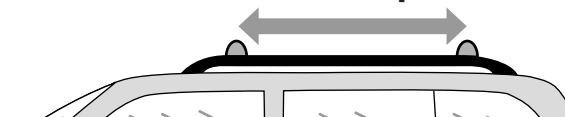

**PROPRIÉTAIRES DE PIEDS Q: IL NE FAUT JAMAIS MODIFIER LA POSITION DES PIEDS Q!**



**RESSERRER LES BARRES SI ON LES A DESSERRÉES.**

**5**

**POSER LE DÉFLECTEUR**

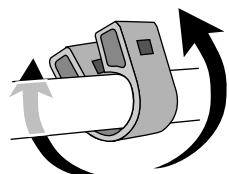

Écarter les colliers SnapAround et les engager sur la BARRE AVANT INFÉRIEURE.

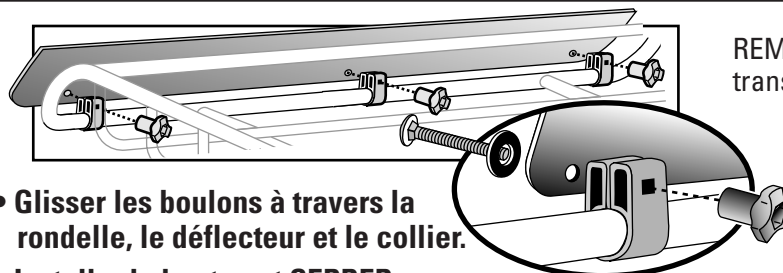

- Glisser les boulons à travers la rondelle, le déflecteur et le collier.
- Installer le bouton et SERRER.

REMARQUE: On peut rabattre le déflecteur quand on transporte des accessoires ou une charge longue.

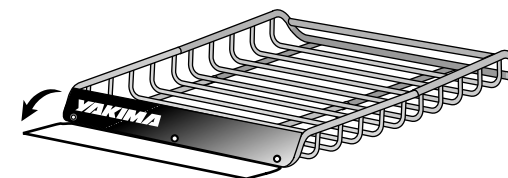

**6**

**DÉPOSER LE PANIER SUR LE PORTE-BAGAGES.** Centrer le panier sur les barres transversales du porte-bagages.

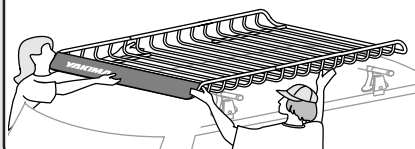

*L'opération est plus facile avec l'aide d'une autre personne.*



**NE PAS FIXER LES ÉTRIERS À DES POINTS INSTABLES**

(Vue de côté)



Ne pas fixer les étriers à ces endroits.

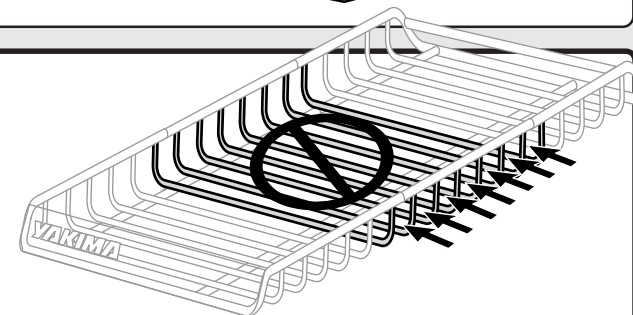

**Remonter les étriers et fixer le panier MegaWarrior allongé — OU — poursuivre à l'opération 5 des instructions accompagnant le panier MegaWarrior.**

ES

1

**SI YA HA INSTALADO UN MEGAWARRIOR:**

- Qúitelo del vehículo.
- Desmonte las escuadras y apártelas.
- Separe las dos medias cestas quitando los tornillos de las juntas.

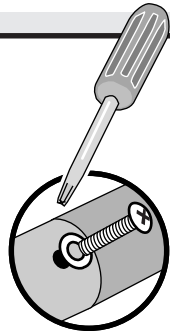

2

**INSERTE EL EXTENSION.**

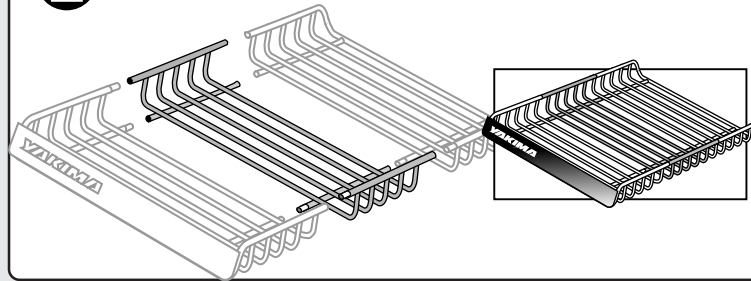

3

Inserte tornillos en cada una de las ocho juntas y apriételos.



4

**• PARA TRAVESAÑOS FIJOS:**

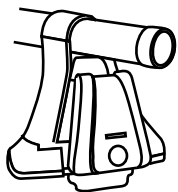

SI TIENE SOPORTES "Q-TOWERS" O TRAVESAÑOS QUE NO PUEDEN MOVERSE: Continúe al Paso 5.

**• PARA TRAVESAÑOS MÓVILES:**

SI LOS TRAVESAÑOS PUEDEN MOVERSE: Aparte los travesaños a una distancia de 91cm (36") a 127cm (50").

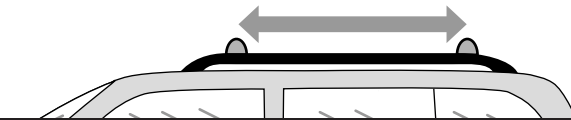

**¡ATENCIÓN: NUNCA CAMBIE DE LUGAR LOS Q-TOWERS!**



**¡AJUSTE LOS TRAVESAÑOS SI LOS HA AFLOJADO!**

5

**COLOQUE LA CARENA.**

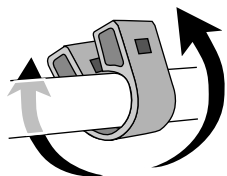

Abra los broches SnapAround y colóquelos sobre el TRAVESAÑO INFERIOR DELANTERO.

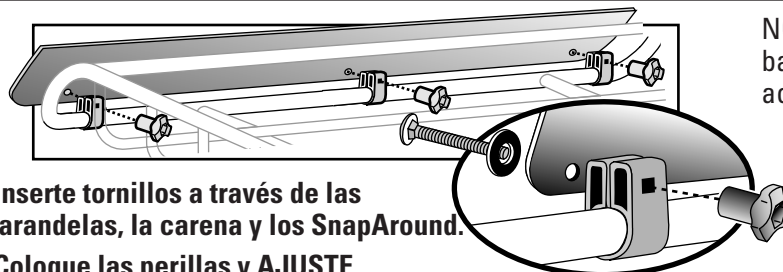

- Inserte tornillos a través de las arandelas, la carena y los SnapAround.
- Coloque las perillas y AJUSTE.

NOTA: Las carenas pueden bajarse para transportar accesorios o cargas largas.

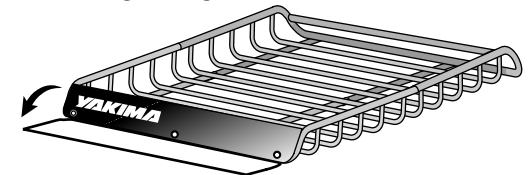

6

**COLOQUE LA CESTA SOBRE LA PARRILLA.**  
Centre la cesta sobre los travesaños.

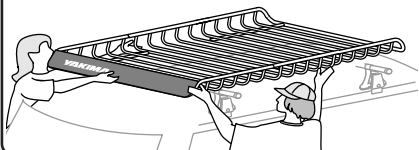

*Un amigo puede facilitar esta tarea.*



**COLOQUE LAS ESCUADRAS SOLO EN LAS SECCIONES DE LA CESTA.**

(VISTA LATERAL)



*Para la primera instalación de las escuadras, consulte las instrucciones del MegaWarrior.*

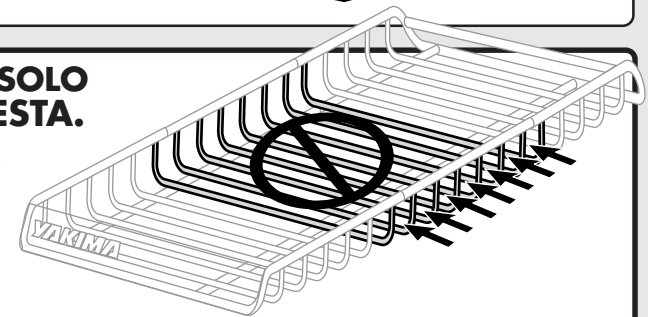

**Vuelva a juntar las piezas e instale el MegaWarrior extendido - O -continúe con el Paso 5 de las instrucciones para el MegaWarrior.**