



GFB *D-FORCE*

DIESEL SPECIFIC ELECTRONIC BOOST CONTROLLER INSTRUCTION MANUAL



Ph: +61 (0)2 9534 0099
Fax: +61 (0)2 9534 3999
Email: sales@gfb.com.au
Web: www.gfb.com.au

CONTENTS

Intro

- 2 About the D-Force
- 3 Optional EGT (Exhaust Gas Temperature) Plugin Module

Installation

- 4 Wiring Diagram
- 5 Optional EGT Plugin Installation
- 6 Solenoid Valve Installation Diagram

Menu Navigation

- 7 Menu Structure
- 8 Boost Presets

Setting the Boost Pressure

- 9 Duty Cycle
- 10 Gain
- 11 Sensitivity

Controller Functions

- 12 Scramble Boost
- 13 Optional EGT - Temperature Units
- 13 Optional EGT - High Temperature Warning
- 14 Overboost Warning
- 14 Peak Hold Display
- 15 Display Setting - Units of Pressure
- 15 Auxiliary Input Setup
- 16 Idle Calibration
- 16 Boost Gauge Calibration
- 17 Colour Settings

Additional Info

- 18 Tips
- 19 Troubleshooting
- 20 Tech and Warranty

ABOUT THE D FORCE

The GFB D-Force boost controller is designed to accurately control boost pressure on all turbo diesel engines that use a traditional wastegate. It incorporates an advanced and unique boost control strategy that allows the user fine control over the peak boost, rise rate, and closed-loop correction.

Please note that the D-Force is NOT recommended for use on turbos of the variable nozzle type, i.e. VNT.

Features at a glance:

- 6 individually programmable boost preset memories, selectable on-the-fly
- Closed-loop correction - helps prevent boost variations
- Unique scramble boost strategy - increase or decrease boost for a certain amount of time at the push of a button
- Overboost protection - shuts down the solenoid and flashes a warning if boost goes too high
- External input - can be used to activate scramble or select boost memories remotely
- Peak-hold display
- Real-time boost gauge display - in BAR, kPa, or PSI
- Adjustable button colours - complement existing interior lighting
- Optional plugin that allows D-Force to display Exhaust Gas Temp

Installing the Head Unit

The D-Force casing is a ½ DIN size, allowing to be mounted into one half of a standard stereo slot.

Alternatively, with its thin profile (18.5mm), the D-Force can be mounted on a vertical face of the dashboard, or stood up on its edge using the supplied double-sided mounting tape.

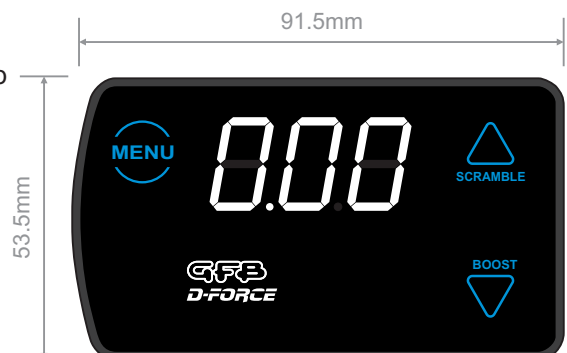

OPTIONAL EGT PLUGIN

The GFB D-Force boost controller is able to display Exhaust Gas Temperature when the optional GFB EGT Plugin is used. Installation of the EGT Plugin is simple, the board and temperature probe connect to the existing D-Force loom, and the probe is supplied with all the hardware required in the exhaust (you will need to weld the supplied bung to the exhaust pipe).

The D-Force kit is available with or without the EGT plugin, and the EGT plugin kit itself is available separately and can be added to an existing D-Force at a later date if desired.

D-Force EBC without EGT plugin - part # 3006

D-Force EBC kit with EGT plugin - part # 3007

EGT plugin kit - part # 3830

The EGT plugin kit (part # 3830) includes:

Plugin board

EGT probe with 2.5m of stainless steel braided wire

Compression gland

Copper washer

Weld-on bung

Menu features involving the EGT display are only accessible when the EGT plugin is connected. These instructions include the EGT plugin and menu items, but where appropriate they are labelled as optional.

In normal operation, the D-Force display can be toggled between EGT and boost pressure simply by holding the MENU button.

EGT can be displayed in °C or °F (see page 13). In either case, temperature is the number displayed x 10, i.e. "48" = 480 degrees.

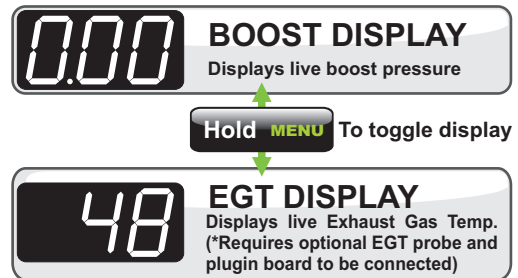

In EGT mode, whenever the probe temperature is below 100°C or 200°F, the display will show 3 spinning segments to indicate the probe is warming up:



Engine Bay

To intake manifold - use small Tee to tap into existing boost reference hose if necessary

1/8" I.D. boost reference hose

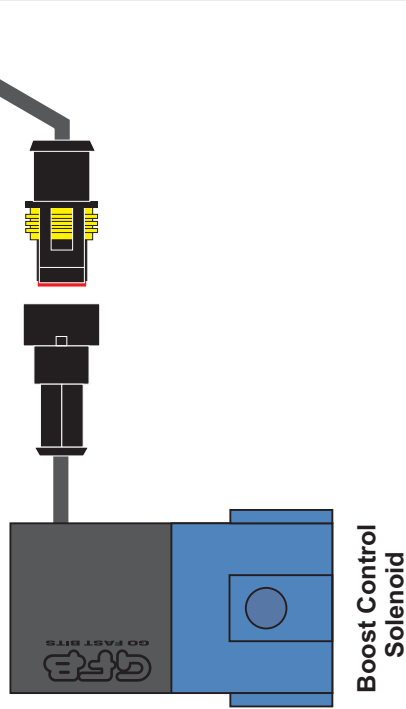

Vehicle Interior



Yellow wire - used to connect to GFB EGT plugin board (see notes below and page 5)

Blue wire - External input (see notes below, and pages 15 & 18 for details)

Red wire - +12V switched power source

Black wire - Vehicle ground (chassis)

Reference hose joiner

Loom

Optional Remote Trigger Circuit

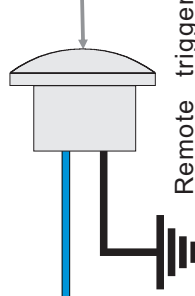

Remote trigger button (not supplied). Use any switch, button or sensor that grounds the blue wire when activated

The external input can be used as a remote trigger simply by connecting it to any kind of switch, button, or programmable ECU output that grounds the blue wire to the vehicle earth when activated. For ideas on different ways to use the external input, see page 18. Once connected, the purpose of the external input must be configured within the "INPUT" sub-menu within the menu (see page 15).

The yellow wire connects to GFB's optional EGT plugin board. If not connected, the EGT sub-menu will not be displayed within the main menu. Once connected, the D-Force display can be toggled between boost pressure and EGT.

If either the blue or yellow wire are not used, simply cut or bundle them and make sure they are insulated.

WARNING! Do NOT connect the blue or yellow wire to a 12V source as this could damage the unit.

Engine Bay

To Boost Control Solenoid

NOTE: EGT probe can be mounted before or after turbo, but note the exhaust temperature will differ between these two locations.

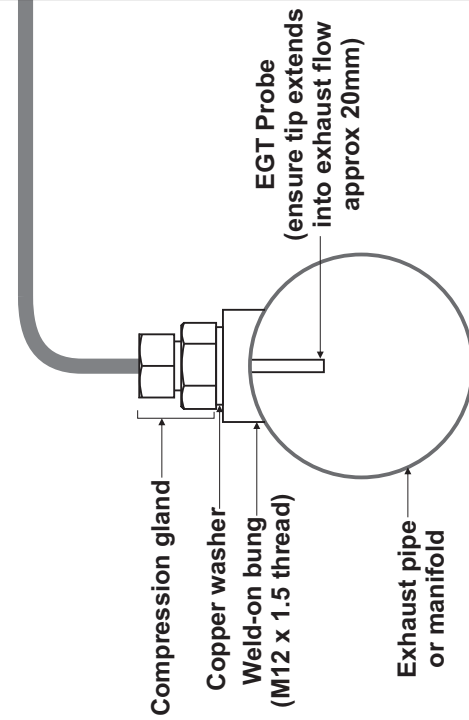

Vehicle Interior

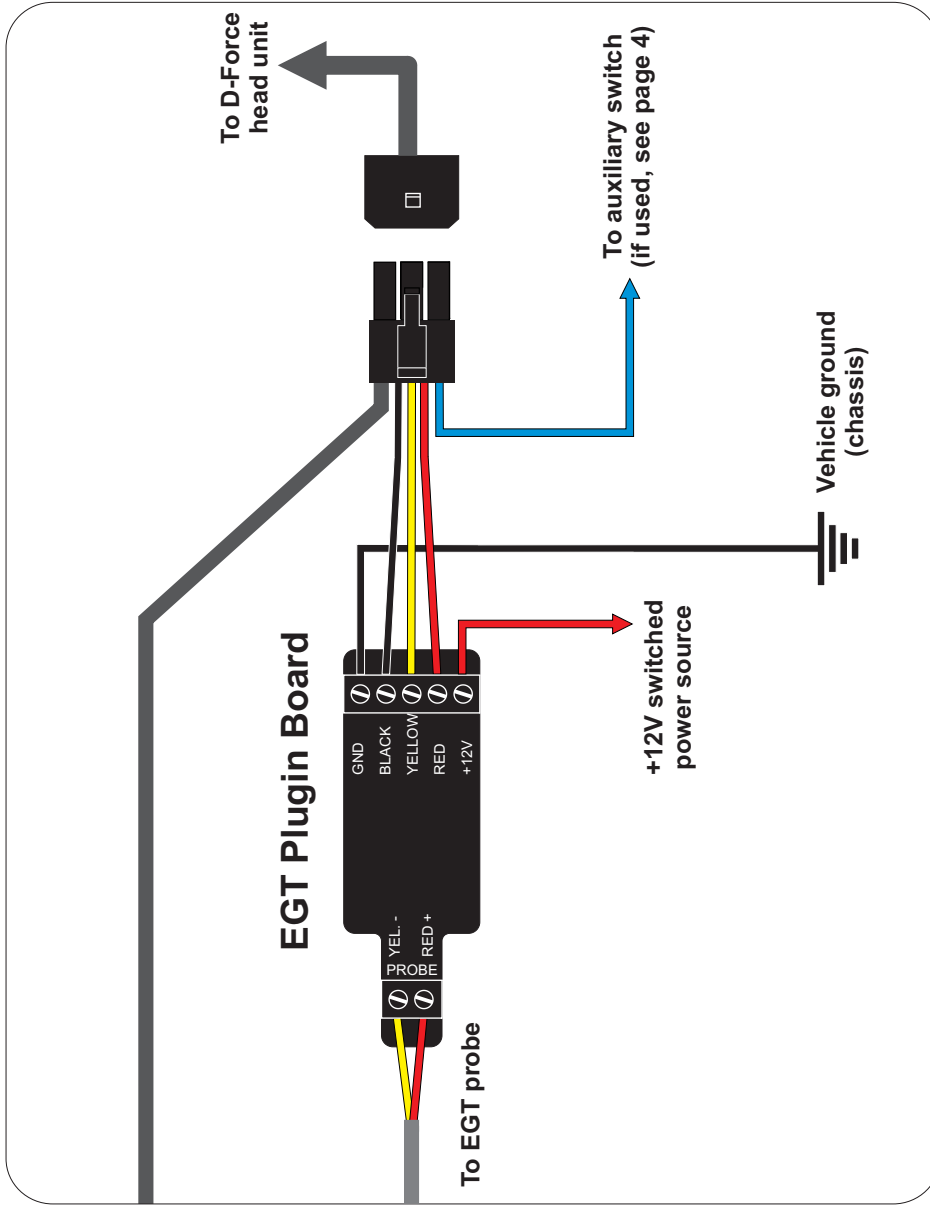

The EGT Plugin board is designed to connect inline with the existing D-Force wiring loom. Take careful note of the wiring diagram above and double-check all connections before powering the unit up. If either the yellow or blue wires from the D-Force are not used, they should be insulated and taped out of the way.

WARNING! Do NOT connect the blue or yellow wire to a 12V source as this could damage the unit.

SOLENOID VALVE INSTALLATION



PLEASE READ before installing the D-Force on a vehicle that has an existing factory-fitted or aftermarket boost control solenoid.

The D-Force is designed to work as a stand-alone boost controller, therefore any existing factory-fitted or aftermarket boost control devices must be removed or disabled.

However, disconnecting a factory-fitted solenoid valve from the car's wiring loom may cause an ECU error code and/or a Check Engine warning light. To prevent this, leave the factory solenoid in place with the electrical wires connected, but remove the hoses.

Please note that the D-Force is NOT recommended for use on turbos of the variable nozzle type, i.e. VNT.

The D-Force solenoid should be mounted in a position away from significant heat sources (such as the exhaust manifold and turbine), and where it is protected from rain or splashed water. The unused outlet of the solenoid valve should be positioned facing downwards to avoid ingress of dust, dirt and water.

DO NOT plug the un-used solenoid port, as this will prevent the controller from being able to adjust boost pressure.

Internal Wastegate

Screw the two supplied hose tails into ports 2 and 3 of the solenoid valve, and connect the ports to the correct locations as shown using the supplied 3/16" hose.

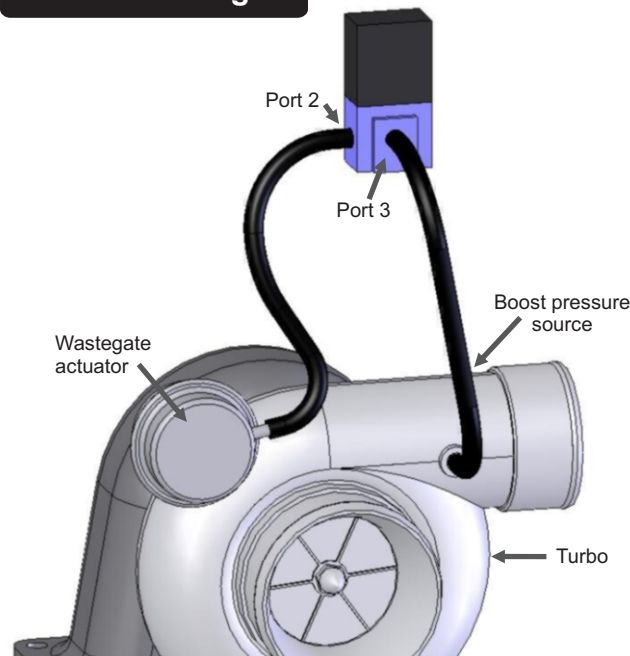

External Wastegate

Screw the two supplied hose tails into ports 1 and 2 of the solenoid valve, and connect the ports to the correct locations as shown using the supplied 3/16" hose.

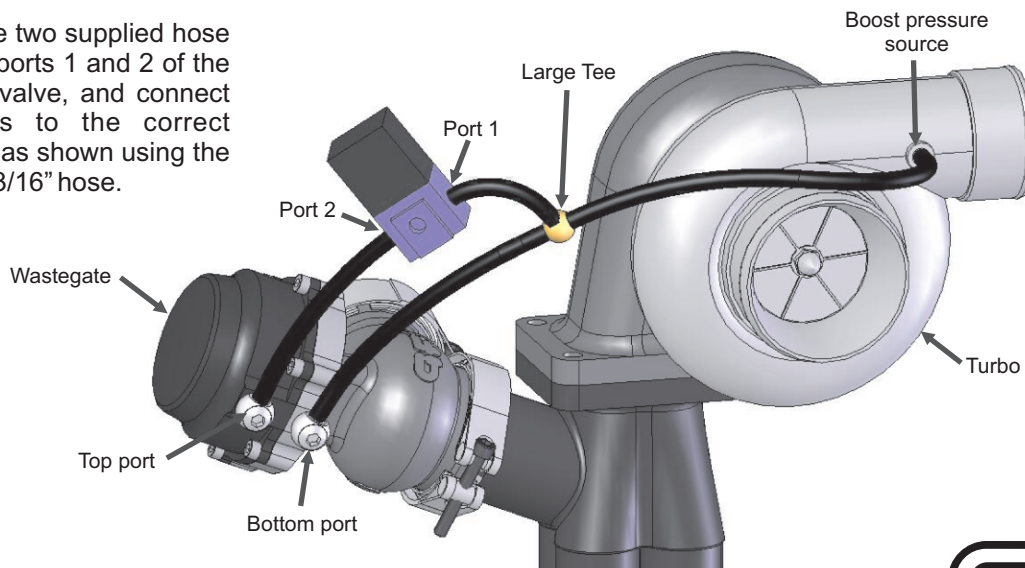

MENU STRUCTURE

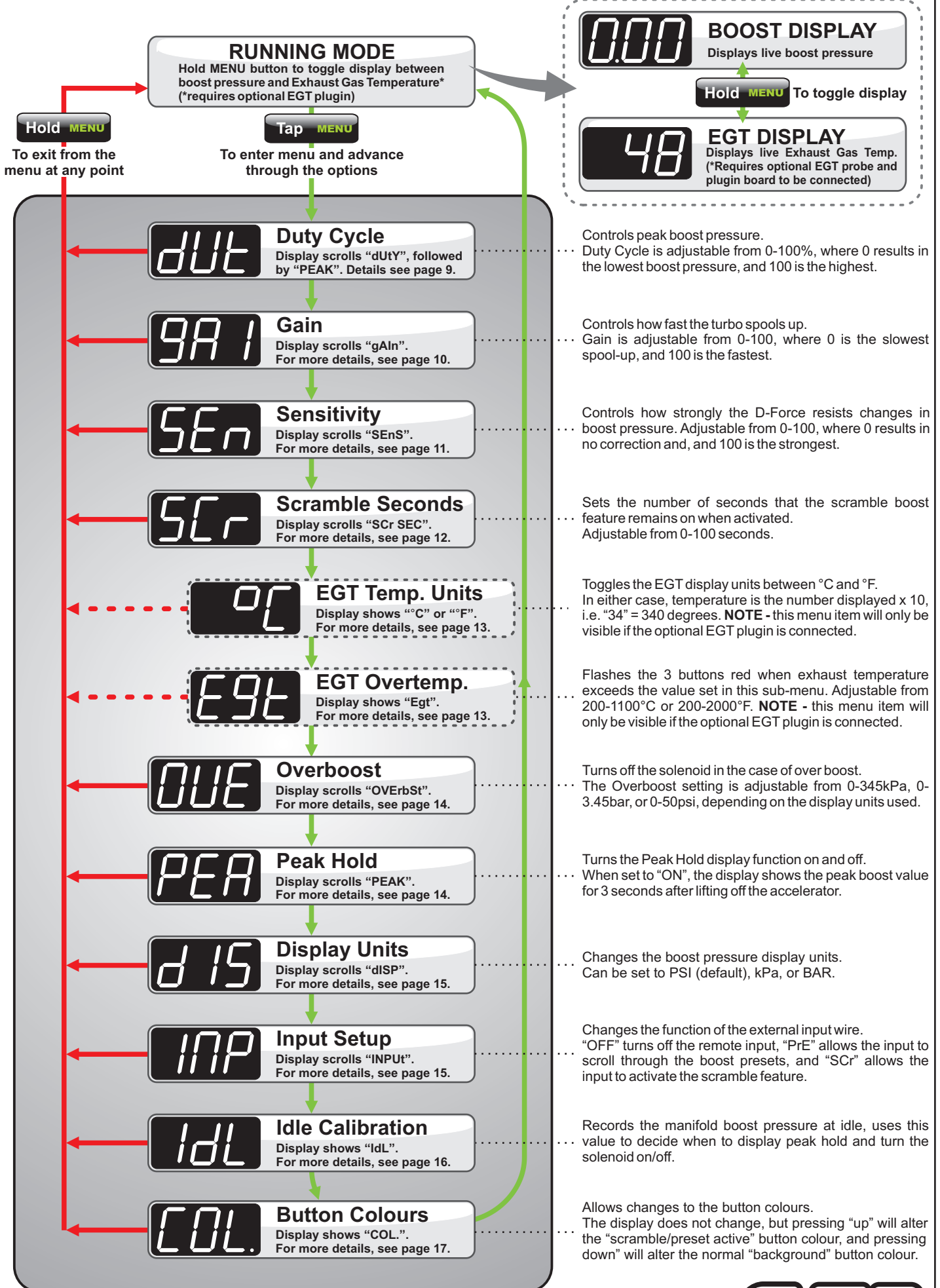

BOOST PRESETS

The D-Force has 6 boost presets (P1-P6), each of which can be individually programmed and accessed quickly on-the-fly using a variety of methods.

There is an additional preset called "SCr", which is the preset that is activated when the scramble feature is used. See page 12 for more info on scramble. "SCr" can be set up and used just like any other preset, so effectively there are actually 7 presets in total.

Whilst 7 presets may be more than most people will use, there are a number of ways they can be utilized to further fine-tune your boost to suit whatever it is you plan to do with your car, whether it be for street, towing, drag or circuit racing. See the suggestions listed on page 18 for ideas on different ways the boost presets (and other features) can be used.

Each boost preset consists of 3 adjustments that can be used to tailor the boost curve:

- **Duty cycle** - controls peak boost pressure
- **Gain** - controls how fast the boost rises
- **Sensitivity** - controls the strength of the closed-loop correction – i.e. how strongly the controller attempts to correct boost pressure changes and taper

Note that it is not necessary to set or use Gain and Sensitivity to set the boost pressure - for simplicity, boost can be controlled only by Duty Cycle if so desired (which is similar to a manual bleed valve). Usually, a well-matched turbo/wastegate/engine will respond very well with only Duty Cycle adjustments, however the additional boost control features are helpful when your goal is to extract the most out of your turbo system.

For best results, these three adjustments should be made in the order listed above, as each correction builds on top of the previous one.

To select boost presets:

From **Running Mode**, Tap **BOOST** (or the remote trigger button if installed and configured, see page 3 and 12 for details) to sequentially scroll through the boost presets from 1-SCr, as shown below:

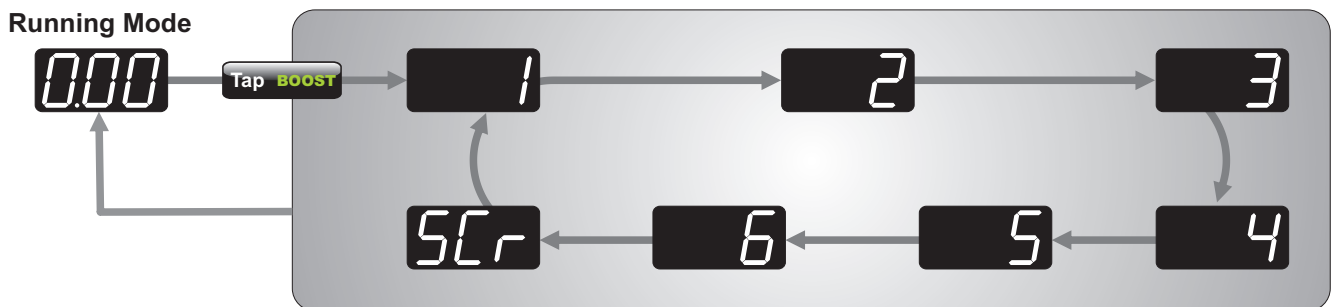

Whenever the down/boost button or remote trigger is used to change the preset, that button changes colour momentarily as an additional visual indication that a preset change has occurred. The colour that the button changes to can be set in the Colour MENU (see page 17).

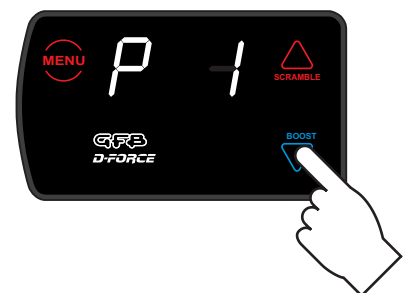

Whenever the engine is not on boost and a new preset is selected, the display will show the boost preset number, followed by the target boost pressure associated with that preset before returning to Running Mode after a few seconds:



If the engine is on boost, the display continues to show real-time boost pressure (doesn't show the preset number or peak boost), but the down/boost button still changes colour to indicate a preset change.



BEFORE adjusting duty cycle, it is **HIGHLY** recommended that you first set up the **OVERBOOST** feature (see page 14 for more information).

OVERBOOST is a “global” setting that will turn off the solenoid if boost pressure exceeds the overboost setting (regardless of the boost preset currently being used), which is intended to prevent damage to your engine if the controller is adjusted incorrectly or accidentally.

The factory default setting is 14.5psi (1 bar, 100kPa).

The duty cycle setting controls the peak boost pressure, and is adjustable from 0-100%, where 0 represents the *lowest* possible boost pressure your turbo system is capable of running (commonly referred to as “gate pressure”), and 100 represents the *highest*. Note however that the controller is generally unresponsive to duty cycles less than 10% or greater than 90%, and therefore all boost presets are factory set to 10%.

See page 20 for a detailed description of what duty cycle is and how it works.

The duty cycle must be increased carefully and incrementally until you arrive at a setting that results in the target boost pressure that you want to achieve.

1. Select the boost preset that you want to adjust (see page 8).
2. Tap “MENU” once to navigate to “Duty Cycle” - the screen will scroll “DUtY”, followed by the current duty cycle setting, then “PEAK”, followed by the current peak boost recorded for that duty cycle setting.
3. Tap the up/down buttons to adjust the duty cycle setting - it is safest to start at 10 so you can see the minimum boost pressure, and make adjustments from there. **NOTE:** whenever you make adjustments to the duty cycle, the “PEAK” boost value will clear to 0.
4. **Do NOT exit the menu!**
5. Drive the car to record the peak boost – you will need to ensure that you perform a full-throttle run, sweeping through the engine’s peak torque RPM in the highest gear possible/practical to ensure the controller records the true peak boost - you can do this as many times as you like until you’re sure you’ve recorded the true peak boost. If you exceed the overboost value, the peak value will be cleared back to 0.
6. Adjust the duty cycle accordingly (higher for more boost), then drive the car again (using the same method as above to ensure consistency) to record the new peak boost.
7. Continue to make adjustments until you achieve your desired peak boost pressure.
8. When done, tap “MENU” to move on to GAIN, or hold “MENU” to exit. In either case, the duty cycle setting and peak boost will be saved to the boost preset that you are currently in. The D-Force will use the stored peak boost as the target, and will use this target boost for the GAIN and SENSITIVITY features. If you do not record a peak boost, the controller will still work, but GAIN and SENSITIVITY will not be able to make any closed-loop corrections.
9. Repeat this procedure for any other boost presets you may wish to set up.

NOTES:

- 0-10% duty means the solenoid valve is completely off, and 90-100% duty is fully on - to run boost pressures that cannot be achieved with 0-100% duty cycle, you must physically change the turbo and/or wastegate - it is not possible to achieve boost pressures outside of this range with the controller alone (or any controller for that matter).
- It is not unusual for duty cycle values of less than 10% to make little change to the boost pressure, because the solenoid valve response is non-linear. That is why the default duty cycle in all boost presets is 10%. You may find you need to adjust it as high as 25% before you start to notice an increase in boost pressure - this is completely normal.
- The higher the required duty cycle to achieve your target boost, the harder boost is to control - it is more likely that boost will taper at high RPM and vary more according to atmospheric conditions with duty cycles in the upper end of the range.
- For the reason above, it may be difficult to run high and low boost pressures that are vastly different from each other, for example a low boost of 10psi and a high boost of 30psi simply may not be possible with the turbo and wastegate.

The Gain setting controls how fast boost pressure rises during spool-up.

NOTE: the gain setting requires a target “peak” boost to be set up in duty cycle. If you adjust duty cycle without performing a boost run, the target boost will be 0 and gain will not function.

Gain is adjustable from 0-100, where 0 gives a factory-like spool up, which is basically the “natural” rise rate of the turbo system. A setting of 100 will attempt to make boost rise **as fast as the turbo system is capable of** by delaying the opening of the wastegate.

Of course it may then be tempting to assume that the obvious setting would simply be 100 for fastest possible spool-up, but in practice this will almost certainly result in an overshoot (boost spike), because the wastegate needs time to move and curb the turbo’s enthusiasm!

Every turbo system is different, and some will handle more gain without noticeable spiking, whilst others may require a lower gain setting. Note that gain is optimum when boost pressure rises as fast as possible WITHOUT spiking.

1. Make sure duty cycle has first been adjusted and peak boost set, as per page 9.
2. Select the boost preset that you want to adjust (see page 8), then navigate to the “Gain” menu (tap “MENU” twice from Running Mode) – the screen will scroll “gAln”, followed by the current gain setting (default is 0).
3. Set gain to 0, then drive the car in such a way that the boost pressure rises as fast as possible – this is usually done by flooring the throttle at relatively high RPM.
4. Now increase the gain setting using the up/down buttons (we suggest initially using coarse adjustments of 10), then drive the car again (using the same method as above to ensure consistency).
5. Note how the boost spool-up rate changes, and continue to adjust the gain setting to achieve the desired boost response. If you notice that boost starts to overshoot the target, reduce the gain setting until boost pressure hits the target consistently without overshooting.
6. When done, tap “MENU” to move on to Sensitivity, or hold “MENU” to exit. In either case, the Gain setting will be saved to the boost preset that you are currently in.
7. Repeat this procedure for any other boost presets you may wish to set up.

NOTE: the Gain function is automatically turned off when making boost pressure adjustments (in Duty Cycle) so that you can record the true peak boost, however the Gain setting will be reactivated when you return to Running Mode.

You may find it necessary to re-adjust the Gain setting after changing the boost pressure.

The Sensitivity setting controls a closed-loop correction factor that attempts to correct any difference between the actual boost and the target boost pressure. This is useful on a turbo that tends to drop boost pressure as RPM rises (boost taper), and can also help pull boost pressure up to the target when it is rising very slowly (such as in a very high gear at low RPM).

NOTE: the sensitivity setting requires a target “peak” boost to be set up in duty cycle. If you adjust duty cycle without performing a boost run, the target boost will be 0 and sensitivity will not perform closed-loop corrections.

Boost taper is common on small factory turbos, because they are typically sized for mid-range response rather than top end power, and as such they tend to “run out of puff” at high RPM.

The Sensitivity feature can help to reduce boost drop-off. It is adjustable between 0-100, where 0 results in no closed-loop correction at all, and 100 is the strongest correction possible.

If the setting is too high, the boost pressure might start getting unstable, so this is another setting that should be tested experimentally to find what works best for your turbo.

If you notice that boost pressure falls away at high RPM and you want to try to correct this behaviour, follow the steps below:

1. Make sure duty cycle has first been adjusted and peak boost set, as per page 9. It is not necessary to set gain for sensitivity to work, but if you do plan to use gain you should set it before adjusting sensitivity.
2. Select the boost preset that you want to adjust (see page 8), then navigate to the “Sensitivity” menu (tap “MENU” three times from Running Mode) – the screen will scroll “SEnS”, followed by the current Sensitivity setting (default is 0).
3. Drive the car in such a way that the boost pressure falls off at high RPM, and take note of the highest pressure drop and the RPM, e.g. boost falls from 18psi at 2500RPM to 15psi by 4500RPM.
4. Now increase the Sensitivity setting using the up/down buttons, then drive the car again (using the same method as above to ensure consistency).
5. Note how the boost taper rate changes, and continue to adjust the Sensitivity setting to achieve the desired result. If you notice that boost starts to become unstable (i.e. oscillates or goes up and down rapidly), reduce the sensitivity setting until stable boost pressure is achieved. It may not always be possible to completely eliminate boost taper depending on how severe it is, but this setting will at least ensure that everything the turbo system is capable of is being delivered.
6. When done, tap “MENU” to move on to the next menu item, or hold “MENU” to exit. In either case, the Sensitivity setting will be saved to the boost preset that you are currently in.
7. Repeat this procedure for any other boost presets you may wish to set up.

NOTE: the Sensitivity function is automatically turned off when making boost pressure adjustments (in Duty Cycle) so that you can record the true peak boost, however it will be reactivated when you return to Running Mode.

There are limits to what the D-Force can do with the existing turbo and wastegate – if the duty cycle setting is already quite high, there is not much adjustment left for the controller to make if boost drops off – once the closed-loop corrections reach 100% duty cycle, there's nothing more it can do as this is the turbo system's limit.

Because of this, it may not always be possible to completely eliminate boost taper, although it should be able to be reduced at the very least. The only solution (in this case) to hold more boost is a larger turbo, stronger wastegate spring, or both.

SCRAMBLE BOOST

Scramble boost is a feature that allows you to increase or decrease boost pressure for a certain amount of time by pressing the “scramble” button on the D-Force’s screen, or clicking a remote-mounted button or switch (not included, see page 4 for details on wiring a remote button/switch). This feature may be useful in the following example situations:

- In a drag-race, the controller could be set up with a lower boost pressure in order to maintain traction off the line. Scramble could then be activated to a higher boost pressure when enough traction is available.
- Scramble could be used as a “push-to-pass” setup, where a little extra boost pressure could help during overtaking, but is not desired at all times for the longevity of the engine.
- In a high-powered car it might be desirable to run lower boost for better drivability, civilised behaviour on the street, or better fuel economy, then use scramble when full power is needed.
- Use scramble to LOWER boost pressure to safeguard the engine, such as when a water spray or water/meth injection bottle is empty, or when transmission/engine oil temps go too high - this could even be set up to be automatic if connected to an existing sensor or warning output.

The D-Force uses a unique scramble approach where it jumps to a dedicated boost preset (SCr) when activated, instead of simply adding extra boost to an existing preset. This method offers much more flexibility in how it can be used because you can tailor the duty cycle, gain, and closed-loop correction specifically to suit the purpose that you intend to use the scramble feature for. In this way, you can raise OR lower boost pressure, as well as change the spool-up rate and closed-loop correction, which cannot be done with traditional scramble methods.

Setting up scramble:

When activated, the scramble feature jumps from whatever boost preset you are currently in to the boost preset called “SCr”. Therefore, you need to set the desired duty cycle, gain, and sensitivity parameters that you want when scramble is activated. To do this, you simply set up the boost preset called “SCr” just as you would for any of the other 6 boost presets (see pages 9-11).

In the scramble menu setting, you adjust the number of seconds that scramble remains active after the button or trigger is released. Once scramble times out, the D-Force returns to the preset you were in previously.

Navigate to the scramble setting (display scrolls “SCr. SEC”) using the “MENU” button, then use the up/down buttons to adjust the scramble time. This setting is adjustable from 0-99 seconds (default is 0). When 0 is selected, the scramble feature is inactive.

Using the scramble feature:

Once the SCr boost preset and scramble seconds are set up, you can activate the scramble feature at any time by tapping the up/scramble button, or grounding the remote input (see below). The up/scramble button will change colour (you can alter the colour that it changes to in the **Colour** menu, see page 17) and scramble will activate immediately. The scramble timer however will only start when you *release* the button. The button will remain lit in a different colour to indicate that scramble is active until the timer finishes.

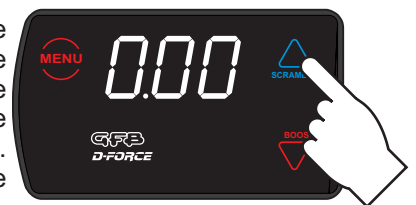

If you want to activate scramble using a remote-mounted button, switch, warning light, ECU output etc, you first need to connect the blue remote wire to the button/switch/ECU output you want to use (see page 4 for wiring diagram), then set the input to “SCr” (see page 15, “Auxiliary Input Setup”). Once you have done this, the remote input will replicate the function of the up/scramble button, and the up/scramble button will also change colour in the same way to indicate when scramble is active.

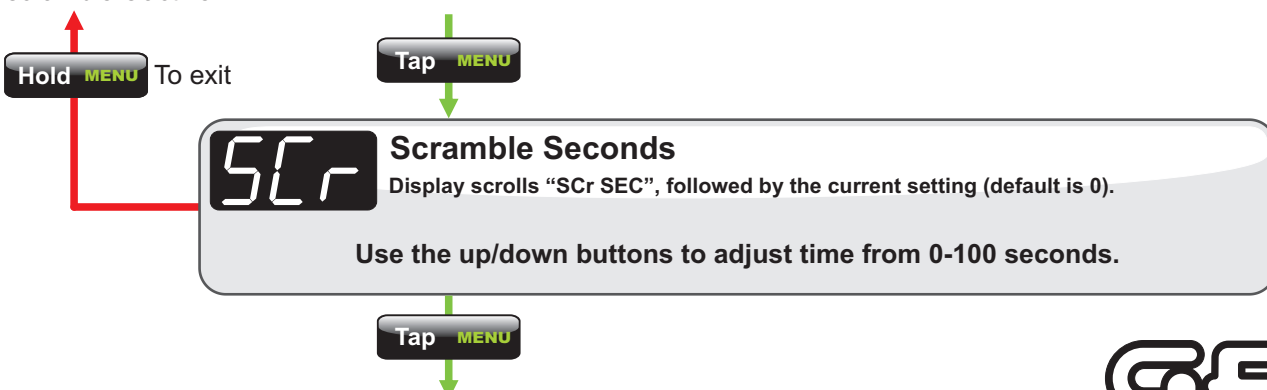

EGT - TEMPERATURE UNITS

The **EGT (Exhaust Gas Temperature) Units** setting is only accessible if the optional EGT plugin board and probe are connected. Without the EGT plugin connected, the menu will skip this setting.

Within this sub-menu, pressing the up button sets the units to °C (default), and pressing the down button sets it to °F.

NOTE: Regardless of the units you select, the display will show the temperature as a number x10.

i.e. 340° C/F will be shown as: 

From **Running Mode**, use the "MENU" button to navigate to the **EGT** setting (display shows either "°C" or "°F")

- Use the "UP/DOWN" buttons to change the units
- Tap "MENU" to save and move on to the next menu item, or hold "MENU" to save and exit to **Running Mode**

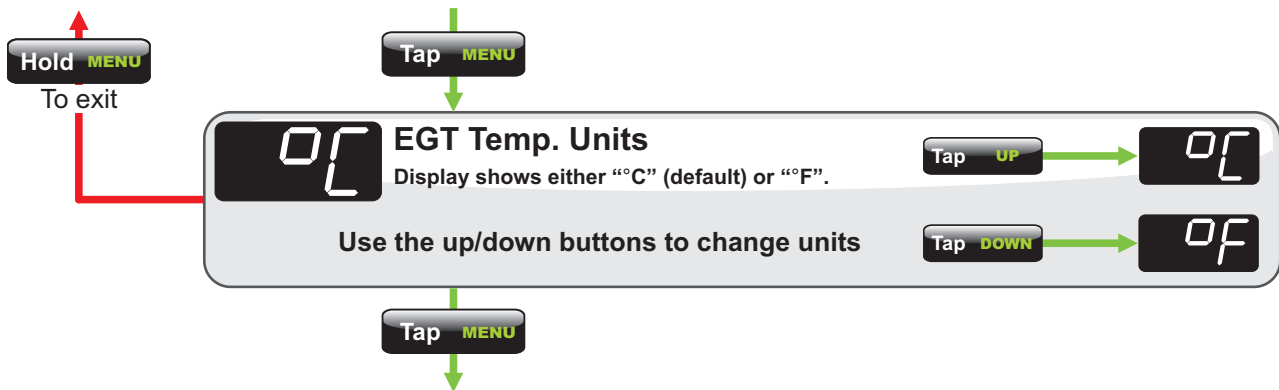

EGT - HIGH TEMPERATURE WARNING

EGT OVERTEMP setting is only accessible if the optional EGT plugin board and sensor are connected. Without the EGT plugin connected, the menu will skip this setting.

This setting is used to activate a visual warning if the EGT exceeds the set value. It will flash the button lights rapidly in red to warn that the EGT is too high (if the button colour is already set to red, they will remain red but flash rapidly). This will occur regardless of whether the display is set to EGT or boost pressure.

NOTE:

Regardless of the temperature units you select in the menu above, the EGT overtemp value is the number x10.

i.e. 650° C/F will be shown as: 

- From **Running Mode**, use the "MENU" button to navigate to the **EGT Overtemp** setting (display shows "Egt")
- Use the "UP/DOWN" buttons to adjust EGT Overtemp value in increments of 10 degrees
- Tap "MENU" to save and move on to the next menu item, or hold "MENU" to save and exit to **Running Mode**



OVERBOOST

Overboost is a safety feature that will turn off the solenoid and flash the buttons red if the boost pressure exceeds the limit set in this menu option. This will help prevent damage to the engine if an accidental or incorrect adjustment is made to the controller, which is particularly helpful during boost setup.

The factory default value for overboost is 14.5psi (1bar, or 100kPa). Overboost is adjustable between 0 - 50psi (0 - 3.45 bar, 0-345 kPa). If you do not want to use overboost, simply set it to the maximum boost pressure.

This is a “global” controller setting, and is therefore the same for every boost preset (including scramble), and is shown in the same pressure units as the display.

We strongly advise setting Overboost BEFORE making boost pressure adjustments. You should choose a maximum limit slightly above your intended peak boost pressure. E.g. if you intend to run say 15psi, set the Overboost for approximately 16.5psi so it doesn't trigger prematurely.

NOTE: The Overboost feature CANNOT protect against a boost overshoot caused by a stuck wastegate or popped wastegate/solenoid hose connection, since these kinds of failures are outside of the D-Force's control.

- From **Running Mode**, use the “MENU” button to navigate to the **Overboost** setting (display scrolls “OVER bSt”)
- Use the “UP/DOWN” buttons to adjust the value
- Tap “MENU” to save and move on to the next menu item, or hold “MENU” to save and exit to **Running Mode**



PEAK HOLD

Peak Hold (when activated) will momentarily display the highest boost pressure recorded during a boost run.

Whenever the boost pressure rises above the idle calibration value (default is 2psi, see page 16 for more info), **Peak Hold** begins recording and will store the highest boost pressure value during that particular “boost event”. When the pressure drops (i.e. during deceleration or idle), the peak boost will be displayed on the screen for 3 seconds. Each time the boost pressure rises above the idle calibration value, **Peak Hold** is cleared and starts recording again.

Peak Hold can be set to “ON” or “OFF”.

- From **Running Mode**, use the “MENU” button to navigate to the **Peak Hold** setting (display scrolls “PEAK”)
- Use the “UP/DOWN” buttons to toggle it on or off
- Tap “MENU” to save and move on to the next menu item, or hold “MENU” to save and exit to **Running Mode**

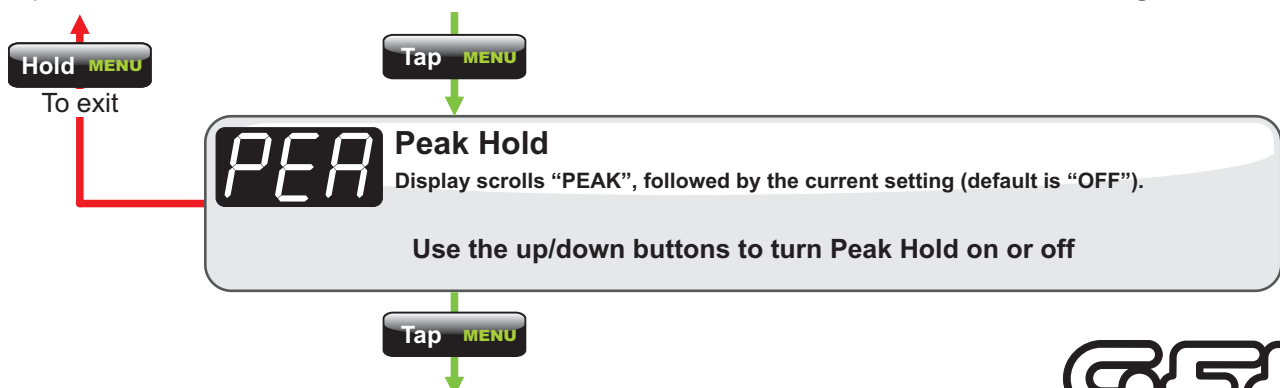

DISPLAY SETTING - UNITS OF PRESSURE

Display allows you to configure the D-Force to display boost pressure in PSI (default), BAR or kPa.

- From **Running Mode**, use the “MENU” button to navigate to the **Display** setting (display scrolls “dISP”)
- Use the “UP/DOWN” buttons to select from PSI (default, “PSI”), BAR (“bAr”) or kPa (“HPA”)
- Tap “MENU” to save and move on to the next menu item, or hold “MENU” to save and exit to **Running Mode**

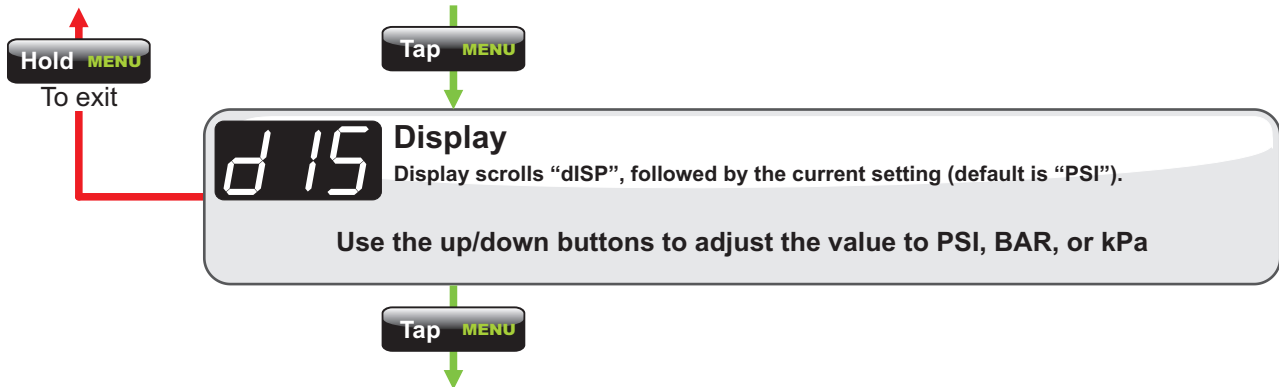

AUXILIARY INPUT SETUP

Input Setup allows you to configure the purpose of the external input (blue wire). For information on how to connect the external input to a button or switch, see the wiring diagram on page 4.

There are three modes for the external input:

- **OFF** - no action
 - **SCr** - the scramble feature is activated when the blue wire is grounded (the same as pressing the scramble button on the screen)
 - **PrE** - scrolls sequentially through the boost presets each time the blue wire is grounded (in the same way as pressing the “down” button in running mode)
-
- From **Running Mode**, use the “MENU” button to navigate to the **Input** setting (display scrolls “INPUT”)
 - Use the “UP/DOWN” buttons to select from “OFF” (default), SCr, or PrE

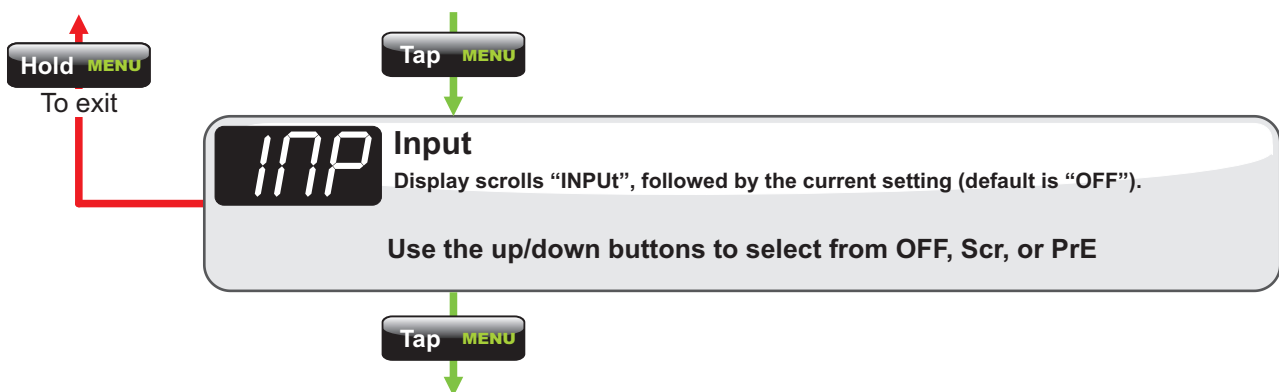

IDLE CALIBRATION

Idle Calibration is a feature that allows you to adjust the switching point that the D-Force uses to determine when the engine is not under load. This switching point essentially tells the D-Force that the engine is no longer under load so the solenoid can be turned off and the Peak Hold value (if activated) can be displayed.

Idle calibration is factory set at 2psi, meaning that any pressure above 2psi is considered “on-boost”, and the D-Force will start controlling boost pressure and recording peak boost (if activated). When pressure then drops below 2psi, the solenoid turns off and peak boost for that run is displayed.

If your car idles or coasts at more than 2psi, you can calibrate the D-Force accordingly.

To do this, use the menu button to scroll to “IdL”, make sure the engine is idling (or coasting), then press and hold the up button until the display shows “CAL”. The D-Force will then measure the current boost pressure, and the display will then show “OH” (O.K.). From now on, the D-Force will turn off the solenoid and display peak boost whenever boost pressure is at or below the value it just recorded.

- From **Running Mode**, use the “MENU” button to navigate to the **IdL** setting (display shows “IdL”)
- Make sure the engine is idling (or coasting)
- Hold the “UP” button to calibrate the unit to the current pressure
- Tap “MENU” to save and move on to the next menu item, or hold “MENU” to save and exit to **Running Mode**

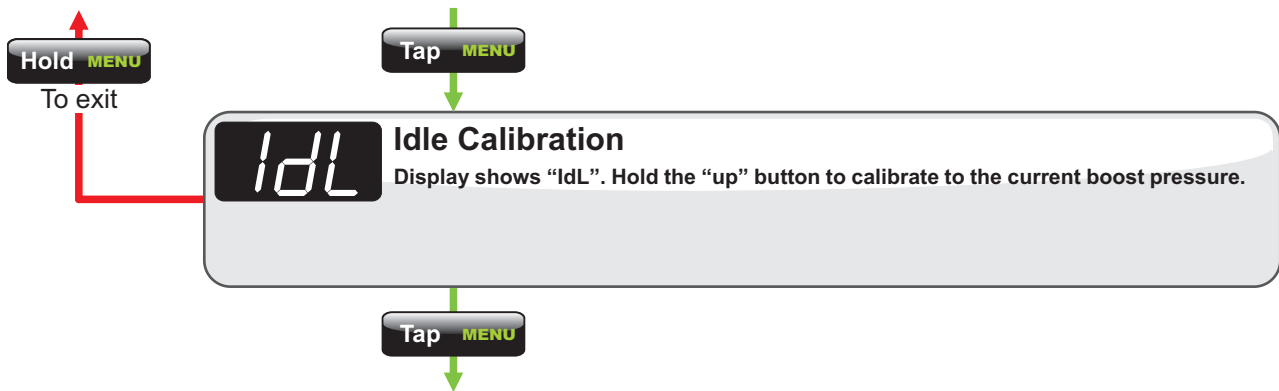

BOOST GAUGE CALIBRATION

Boost Gauge Calibration is a feature that is not accessed via the menu. It is only to be used if the boost gauge display does not read zero with the engine off.

- To re-zero the boost gauge:
- Turn the ignition off
 - Turn the ignition on, but **DO NOT START THE ENGINE**
 - When the display starts to show “gFb”, press and hold the down button
 - When the display shows “CAL”, you can release the down button
 - The display will now show “OH.” (i.e. “OK”) to indicate a successful calibration
 - The D-Force is now functional and the gauge will read zero

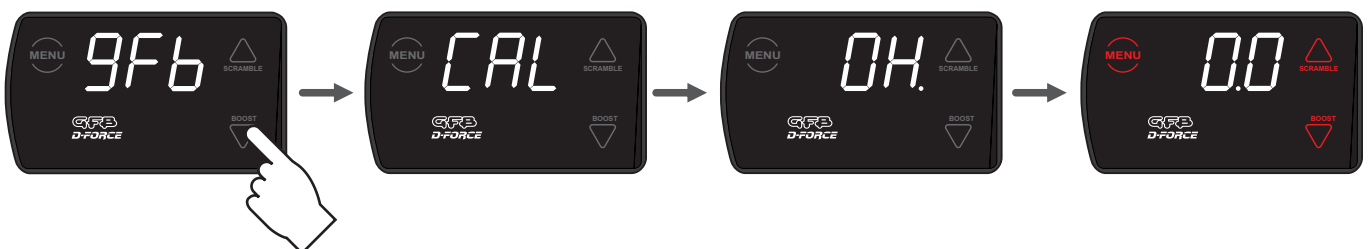

GO FAST BITS

COLOUR SETTINGS

Colour allows you to configure the button colours - both the normal “background” colour (i.e. when not pressed), and also the “feature active” colour, which is the colour a button turns when either scramble or preset features are activated (see pages 6 and 10).

There are 7 colour options available:

- Red
- Green
- Blue
- Aqua (green/blue)
- Purple (red/blue)
- Yellow (green/red)
- Off (no light)

“Off” is provided as an option, which could be used for example if you don’t want the buttons lit at night, but still want a visual indication when scramble is activated.

Within the **Colour** menu, **Tap BOOST** to scroll through the “background” colour options - you will see the buttons change colour as you do this - the display screen will not change.

Tap SCRAMBLE to scroll through the “activated” colour options - you will see the button you are tapping briefly change colour, indicating what all buttons will change to when activated.

Example 1: Changing “background” colours

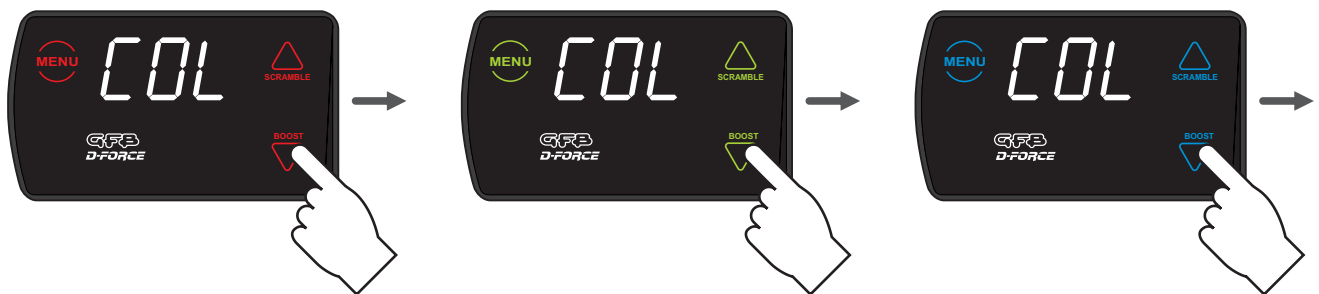

Example 1: Changing “feature active” colours

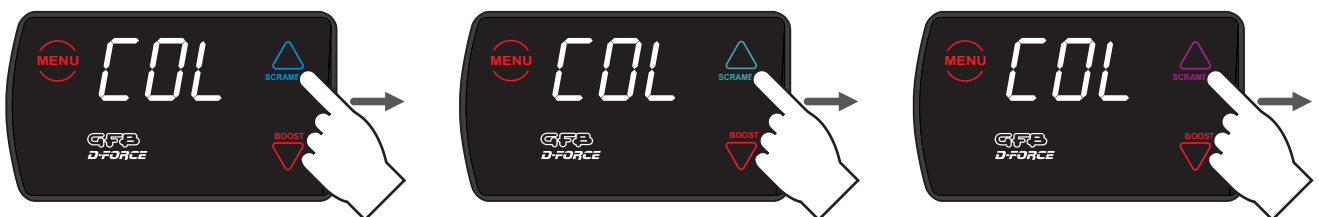

- From **Running Mode**, use the “MENU” button to navigate to the **Colour** setting (display shows “COL”)
- Use the “UP/DOWN” buttons to make your selection as described above
- Tap “MENU” to save and move on to the next menu item, or hold “MENU” to save and exit to **Running Mode**

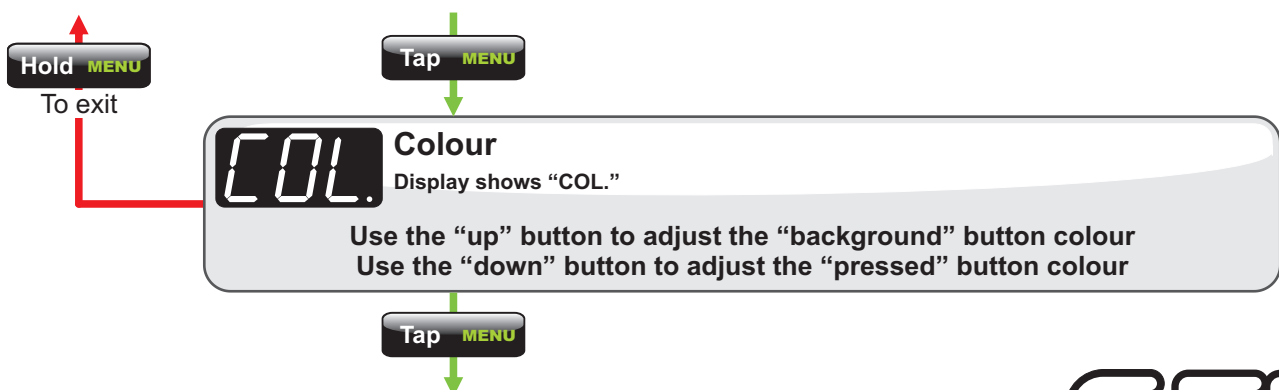

Here are some handy suggestions for different ways you can set up and use the features on your D-Force.

If you set the "INPUT" menu item to "SCr" (scramble), then you can use the external input wire to trigger scramble in a variety of different ways to achieve different outcomes.

For example, you can connect the external input wire to:

- Steering wheel button - easy access to use as a "push-to-pass" system. You can drive normally on low boost and access high boost immediately when required (or when you have traction). If you set the scramble seconds to 0, it will return to low boost as soon as the button is released, or you can have it time out after a few seconds.
- Throttle switch - using a micro-switch on the throttle pedal (like a "kick-down" switch), or a configured output from an aftermarket ECU, you can make the scramble feature activate when the throttle is floored, for an "automatic" version of "push-to-pass" - i.e. you get high boost when you need it simply by flooring the throttle.
- Brake/handbrake switch - you can activate high boost after a certain amount of time has passed during a drag race to aid traction off the line. In this case, you would set the scramble boost preset to a lower boost setting for launch, and set the scramble seconds to whatever time you want to engage the high boost setting (i.e. when scramble times out). So when you are staging, the brake pedal/handbrake is held and scramble is active on a low boost preset. When the brake is released and the run begins, the scramble timer starts and will turn off after the chosen amount of time, reverting back to the original (high) boost preset.
- Toggle switch - use a toggle (on/off) switch instead of a momentary button (press and release) to keep scramble activated as long as the switch is on. This method gives you easy high/low boost selection, and the different coloured illumination on the scramble button gives you a good visual reminder that scramble is active.
- Warning light or programmable output from ECU - if you have other warning devices such as low water level (for water injection/intercooler spray), or high intake air/water/oil/transmission temperature, you could use such a warning light or programmable ECU output to activate scramble to a lower boost pressure to help protect the engine.

If you set the "INPUT" menu item to "bOOST" (boost preset selection), every time you activate the external input, the controller jumps to the next boost preset.

This can be used to set up a kind of "boost-by-gear" feature for drag racing situations. You would connect the external input to a clutch switch or gear selector switch in such a way that it triggers with each gearshift. Then, when you stage your car, manually select boost preset 1 using the buttons on the D-Force, and then each time you shift gears after your launch, the external input on the clutch or gear selector will activate the next boost preset. Since there are 6 boost presets, you can tailor the peak boost, rise rate and taper for each gear.

Boost pressure remains the same regardless of the duty cycle setting:

Turn the ignition off, then on again and listen for the solenoid to click rapidly for about 1 second. If you can't hear it click on power up, check the wiring loom to the solenoid valve.

If the solenoid does click rapidly on power up, check the hose connections to the solenoid valve and wastegate - make sure the un-used solenoid valve port is not plugged, and that the boost pressure and wastegate hoses are connected to the correct ports.

Check the controller is receiving full battery voltage. If it is powered off a low voltage supply, the display will work but the solenoid will not.

The peak boost pressure always seems to be higher than the target that was originally set:

The car may not have been driven in a way that achieved the "true" peak boost whilst duty cycle was being set up. Go back into **Duty Cycle** and either reduce the duty cycle value so that peak boost comes down to where you want it, or leave the duty cycle alone and drive the car again to learn the "true" peak boost.

Boost pressure spikes (overshoots the target):

Reduce the **Gain** setting

Boost spiking should not be confused with boost taper (see below). Boost taper often looks similar to spiking in low gears because the RPM increases so quickly.

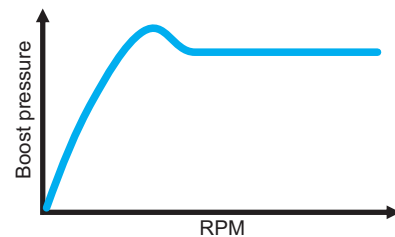

Boost pressure oscillates significantly:

Reduce the **Sensitivity** setting

If the closed-loop correction is set too high, the boost may fluctuate rapidly up and down, which is a sign that the system is going "unstable". It means the correction is too strong. A lower value will eliminate the instability, but note that boost may still drop off a little at high RPM because the turbo is nearing its limits (see boost taper below).

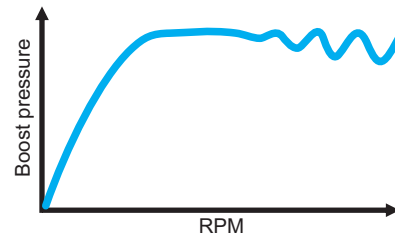

Boost tapers off even with a high Sensitivity setting

This is a sign that the turbo system is operating beyond its efficient limits. Either the turbo is too small to hold high boost to redline, or the wastegate spring is too soft. If you are using a duty cycle of more than 70%, it's possible that a stronger wastegate spring and lower duty cycle will hold a more stable boost pressure.

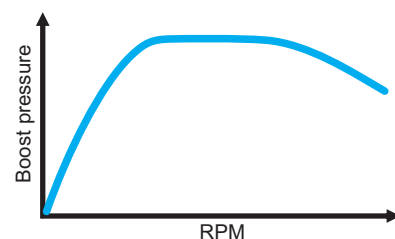

Boost pressure starts to increase significantly at high RPM:

This is called boost creep, which is a result of the wastegate not being large enough. It may hold boost stable for some of the rev range, but at high RPM it is wide open and not flowing enough to prevent boost from rising further. At this point the D-Force can do no more, the only solution is a larger wastegate.

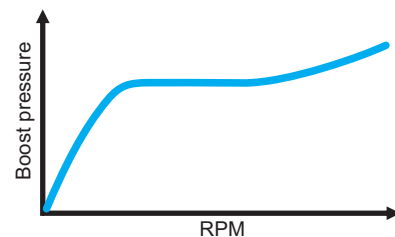

Gain and Sensitivity settings have no effect:

Make sure the preset you are adjusting has a target boost recorded. Press menu to enter the duty cycle setting, and watch the screen. If it shows a value of zero, you need to remain in duty cycle and perform a full throttle run to record a target boost. Only then will Gain and Sensitivity work.

Duty Cycle - what the heck is it?

Duty cycle refers to how the solenoid valve is actually controlled. The D-Force boost controller outputs a signal to the solenoid valve that rapidly pulses it on and off about 30 times a second (0.033 seconds per cycle) to bleed air from the wastegate. Duty cycle alters how long it is on for each cycle, and how long it is off.

For example, a duty cycle of 25% means that the solenoid valve is pulsed ON for 25% of each cycle, and OFF for 75% of the cycle. A 25% duty cycle output from the D-Force to the solenoid valve is illustrated opposite:

The higher the duty cycle, the longer the solenoid is pulsed on each cycle, which bleeds more air from the wastegate actuator, resulting in a higher boost pressure.

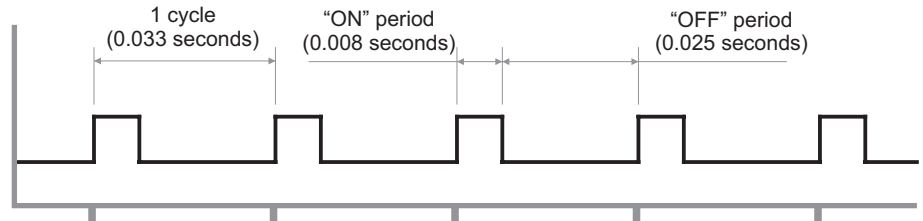

Duty Cycle limits

Pulsing the solenoid at 0% duty cycle means that all of the pressure gets to the wastegate, which is effectively the same as having no boost controller, meaning the turbo will run the minimum pressure (aka "gate" pressure) possible.

Running the solenoid at 100% duty cycle prevents ALL of the pressure from getting to the wastegate, which is effectively the same as removing the hose from the wastegate altogether, which results in the highest boost pressure the turbo is capable of supplying.

Why can't I just dial-in how much boost I want instead of fiddling with duty cycle?

Fair question. Unfortunately, the D-Force (or any boost controller for that matter) doesn't know what boost pressure your specific turbo/wastegate/engine/weather conditions/etc will return for a given duty cycle - there simply is no formula that says "for this turbo on that car, "X"% duty cycle will give "Y"psi of boost".

The controller NEEDS to know this relationship between duty cycle and resulting boost pressure, because when boost is rising quickly, it must pulse the solenoid at the correct duty cycle **BEFORE** the boost reaches the target boost pressure. If it doesn't know the correct duty cycle, it cannot do this.

The reason it must pulse the solenoid before boost reaches the target is because there is always a small delay between the controller making a change to the duty cycle, and the wastegate (and therefore boost pressure) responding to the change. This delay means that if the controller simply waited until the boost pressure reached the target and then responded accordingly, boost pressure would overshoot the target.

Therefore, the only way to determine the duty cycle/boost relationship is through trial-and-error, by starting at a low duty cycle, reading the resulting boost pressure, and increasing it until you reach the desired boost.

Once the D-Force knows the duty cycle that results in the target boost pressure, it can then make changes to the duty cycle to compensate for small variations in boost (when a value for "Taper" has been entered).

WARRANTY

All products manufactured or distributed by Go Fast Bits P/L are subject to the following Limited Express Warranties, and no others:

For a period of one year from and after the date of purchase of a new Go Fast Bits product, Go Fast Bits warranties and guarantees only to the original purchaser/user that such a product will be free from defects of material and/or workmanship in the manufacturing process. Go Fast Bits, at its sole discretion, shall replace or repair a defective product. This express warranty shall be inapplicable to any product not properly installed or properly used by the purchaser/user or to any product damaged or impaired by external forces. This is the extent of warranties available on this product. Go Fast Bits shall have no liability whatsoever for consequential damages following from the use of any defective product or by reason of failure of any product. Go Fast Bits specifically disclaims and disavows all other warranties express or implied including, without limitation, all warranties of fitness for a particular purpose, warranties of description, warranties of merchantability, trade usage or warranties of trade usage.